

👁 Note!

Please note that there can be small differences between your product and the images in these instructions.

👁 Note!

Please note that during storage and transport, especially at high ambient temperature, some of the oil and grease used for assembly may leak and stain the packaging. This will not cause damage to the product, wipe off the excessive oil or grease with a cloth.

Kit Contents

Description	Part No	Pcs
Shock absorber	HO568	1
Sticker Set	10207-01	1
Sticker Memo notes	01180-01	1
Owner's manual	07242-07	1

👁 Note!

Before you install this product, check the kit contents. If anything is missing, please contact an Öhlins dealer.

⚠ Warning!

Before you install this product, read the Öhlins Owner's manual. This product is an important part of the vehicle and the vehicle stability.

👁 Note!

For CBR1000RR-R SP you need to go to a Honda dealer to turn off the electronic suspension functionality. Be aware that this also turns off the front fork functionality, so an Öhlins After Market front fork or cartridge kit with manual adjusters is needed as well. For racing, a Honda race ECU and wire harness is recommended. This is without electronic suspension functionality.

Shock absorber for Honda CBR1000RR-R/SP

HO 568

Mounting Instructions

MOUNTING INSTRUCTIONS

⚠ Warning!

We strongly recommend to let an Öhlins dealer install this product.

⚠ Warning!

If you work with a lifted vehicle, make sure that it is safely supported to prevent it from tipping over.

👁 Note!

When you work with this product, see the vehicle service manual for vehicle specific procedures and important data.

👁 Note!

Before you install this product clean the vehicle.

1

Put the motorcycle on a stand so that the rear wheel is off the ground by a couple of dm.

2

Remove the seat.

3

Remove 6 body clips (press the middle part and pull).

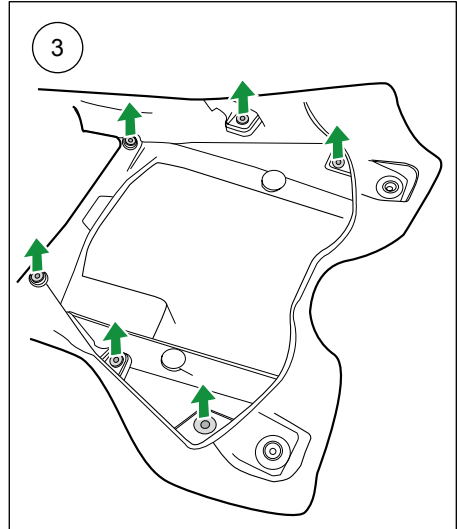

MOUNTING INSTRUCTIONS

4

Remove tank cowl (there are 4 bolts to remove).

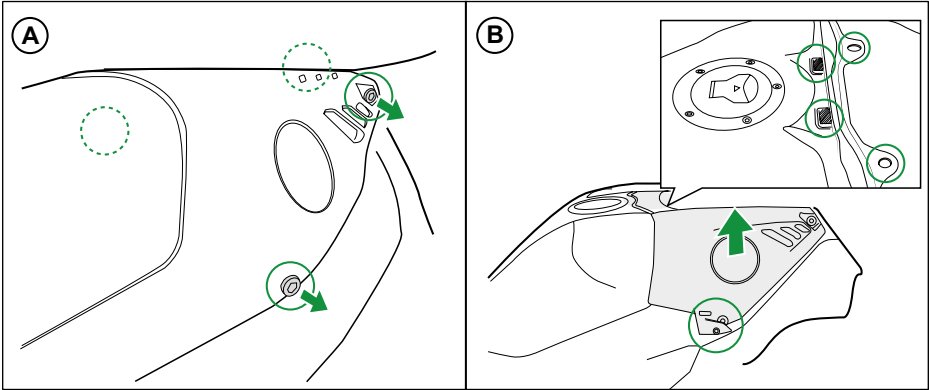

5

Remove the side cowls.

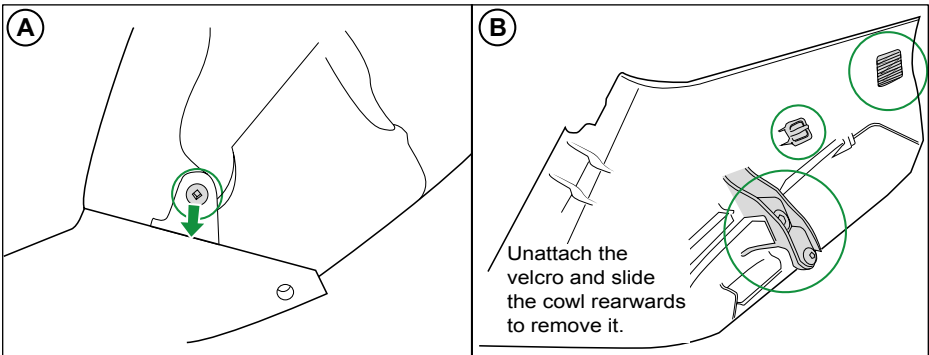

MOUNTING INSTRUCTIONS

6

Remove tank bolts, tank hoses and tank connector.

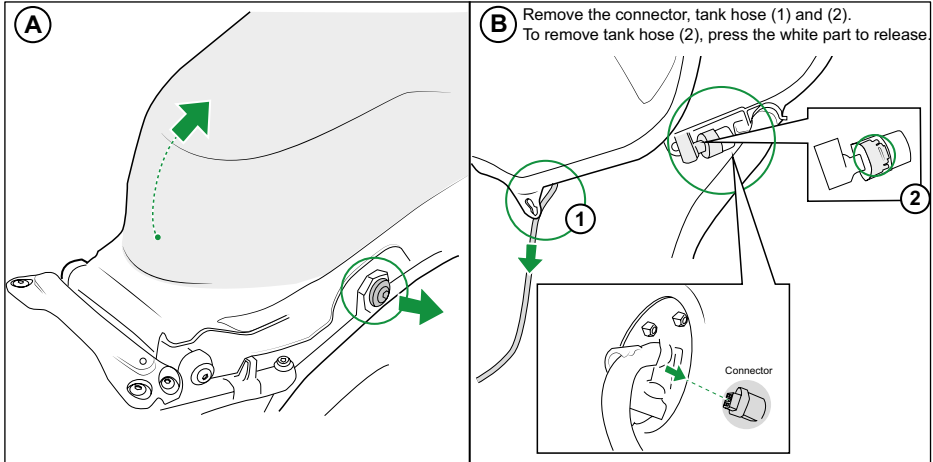

7

Remove the tank.

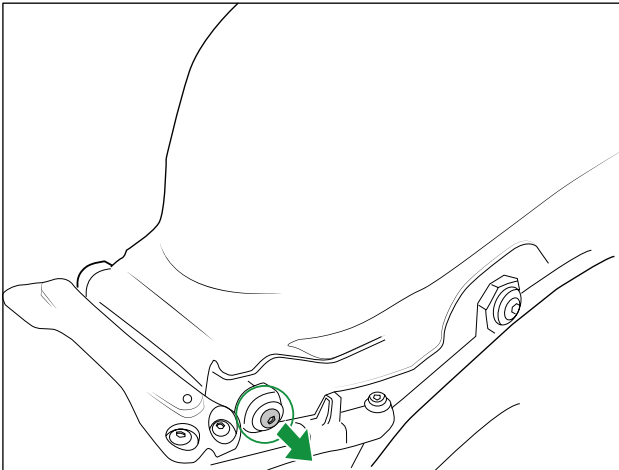

MOUNTING INSTRUCTIONS

8

Remove the shock absorber upper bolt.
Disconnect the shock absorber's electric connectors, if –SP model.

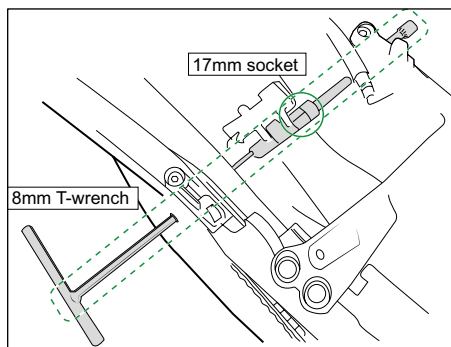

9

Remove the shock absorber lower bolts.

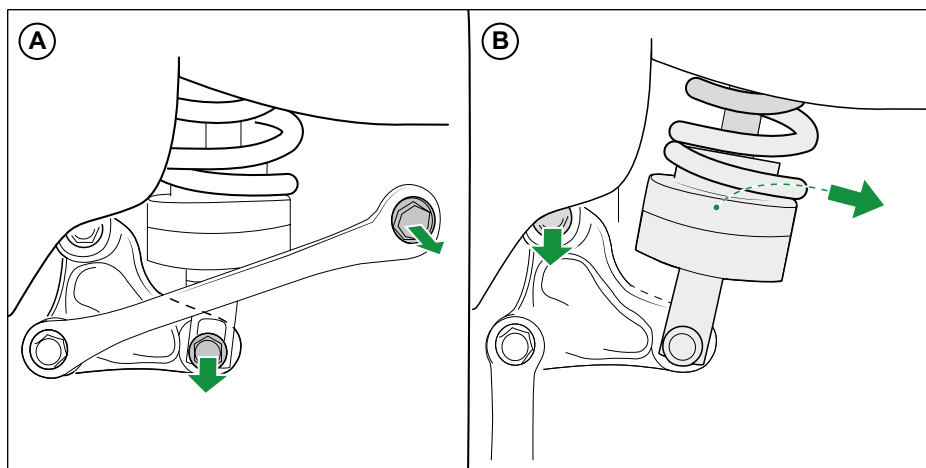

10

Lower the swing arm and remove the shock absorber upwards.

11

Mount the Öhlins shock absorber in reversed order.

12

Mount everything else (cowlings, tank, etc) back, in reversed order.

ADJUSTMENTS

⚠ Warning!

Before you ride/drive, always make sure that the setup is according to the recommended setup data. Read about adjustments and setting up in the Öhlins Owner's Manual before you make any adjustments. Contact an Öhlins dealer if you have any questions about setting up.

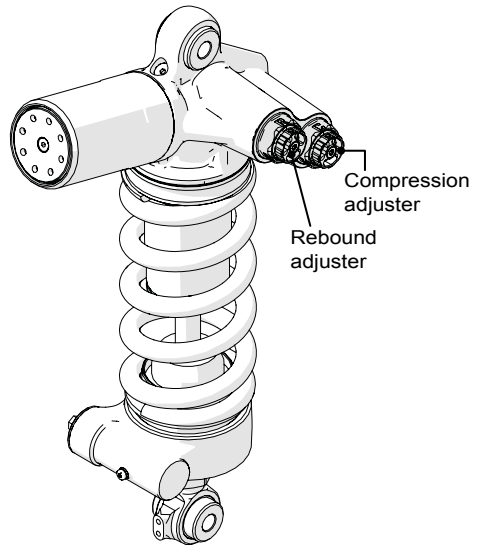

SETUP DATA

Length	317 +4/-2	mm
Stroke	60	mm
Compression	12	clicks
Rebound	14	clicks
Spring preload	13	mm
Spring	21040-39	
Spring rate	110	N/mm
Spring free length	160	mm

Recommended free sag and ride height		
R1-R2		
R1-R3	30	mm
F1-F2		
F1-F3	40	mm

Öhlins products are subject to continuous improvement and development, therefore, although these instructions include the most up-to-date information available at the time of printing, minor updates may occur.

To find the latest information contact an Öhlins distributor. Please contact Öhlins if you have any questions regarding the contents in this document.

Part no. MI_HO568_0
Issued 2020-01-08

© Öhlins Racing AB. All rights reserved. Any reprinting or unauthorized use without the written permission of Öhlins Racing AB is prohibited.

Öhlins Racing AB
Box 722
S-194 27 Upplands Väsby, Sweden
Phone +46 8 590 025 00
fax +46 8 590 025 80



www.ohlins.com